

2

1

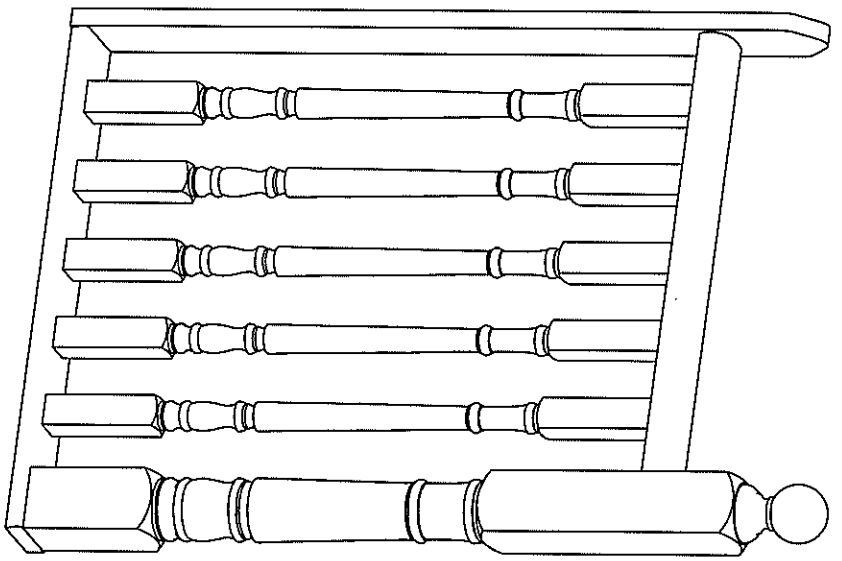
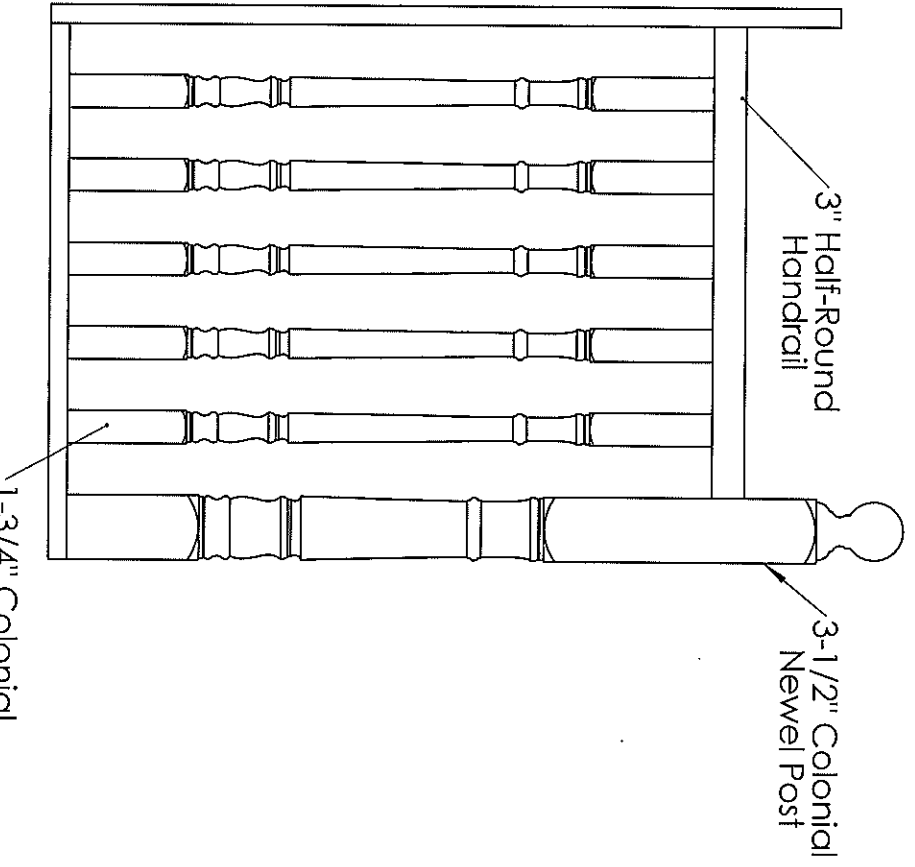

A

B

TITLE:

A

B

2

1

PROPRIETARY AND CONFIDENTIAL

THE INFORMATION CONTAINED IN THIS DRAWING IS THE SOLE PROPERTY OF Airport Railings Co. Ltd. ANY REPRODUCTION IN PART OR AS A WHOLE WITHOUT THE WRITTEN PERMISSION OF Airport Railings Co. Ltd. IS PROHIBITED.

Railing Packages

SIZE DWG. NO.

A Standard 1 Package

SCALE: 1:20 WEIGHT: SHEET 1 OF 1

2

1

B

A

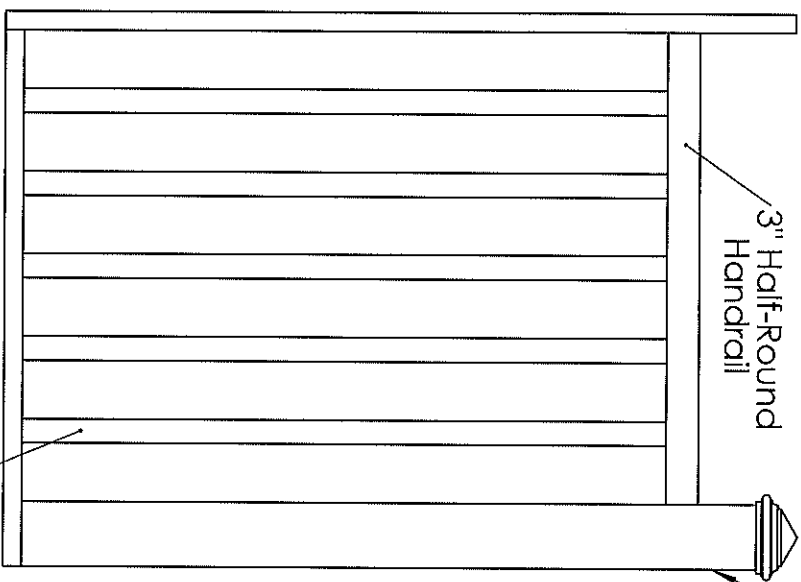

3-1/2" Square Plain Newel Post

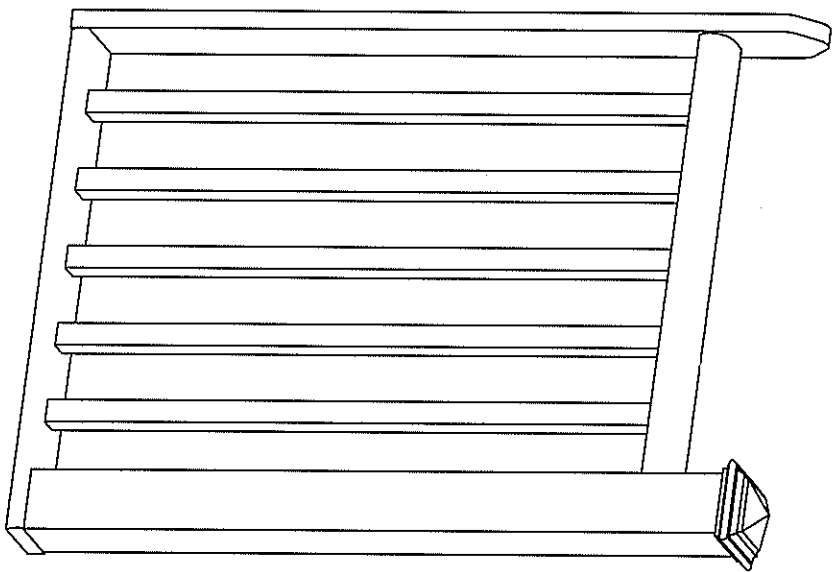

B

A

TITLE:

Railing Packages

SIZE DWG. NO.

A Standard 2 Package

SCALE: 1:20/WEIGHT: SHEET 1 OF 1

PROPRIETARY AND CONFIDENTIAL

THE INFORMATION CONTAINED IN THIS DRAWING IS THE SOLE PROPERTY OF Airport Railings Co. Ltd. ANY REPRODUCTION IN PART OR AS A WHOLE WITHOUT THE WRITTEN PERMISSION OF Airport Railings Co. Ltd. IS PROHIBITED.

2

1

2

1

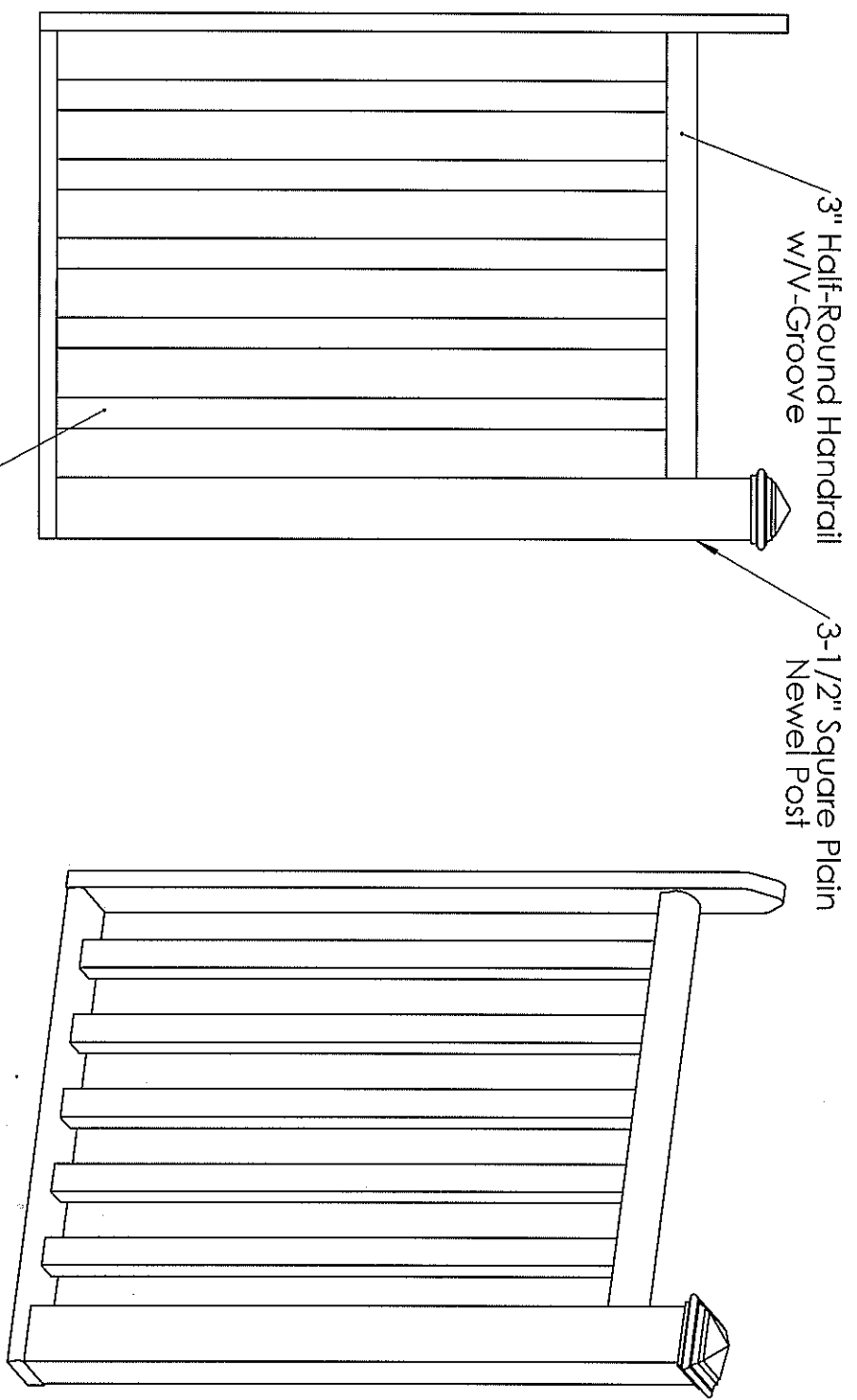

A

B

A

B

TITLE:

Railing Packages

SIZE : DWG. NO.

A A-1 Package

SCALE: 1:20 WEIGHT: SHEET 1 OF 1

PROPRIETARY AND CONFIDENTIAL

THE INFORMATION CONTAINED IN THIS DRAWING IS THE SOLE PROPERTY OF Airport Rollings Co. Ltd. ANY REPRODUCTION IN PART OR AS A WHOLE WITHOUT THE WRITTEN PERMISSION OF Airport Rollings Co. Ltd. IS PROHIBITED.

2

1

2

1

A

B

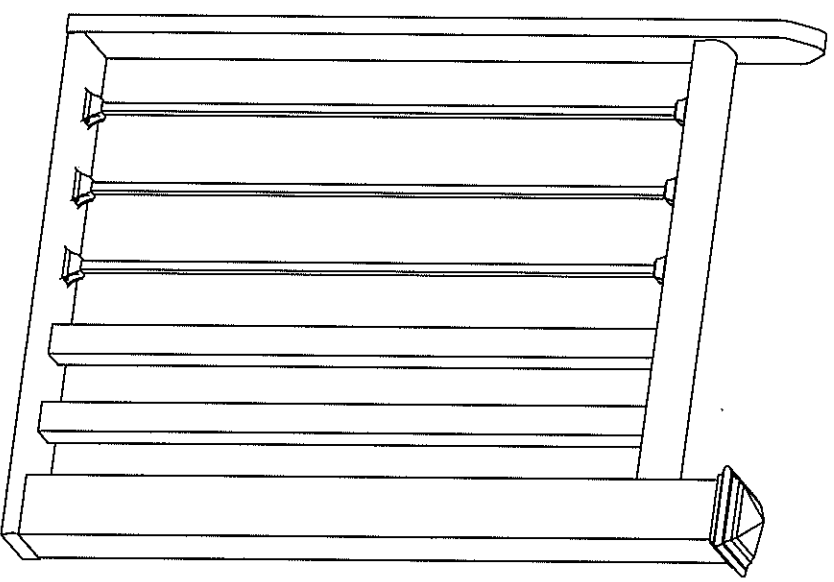
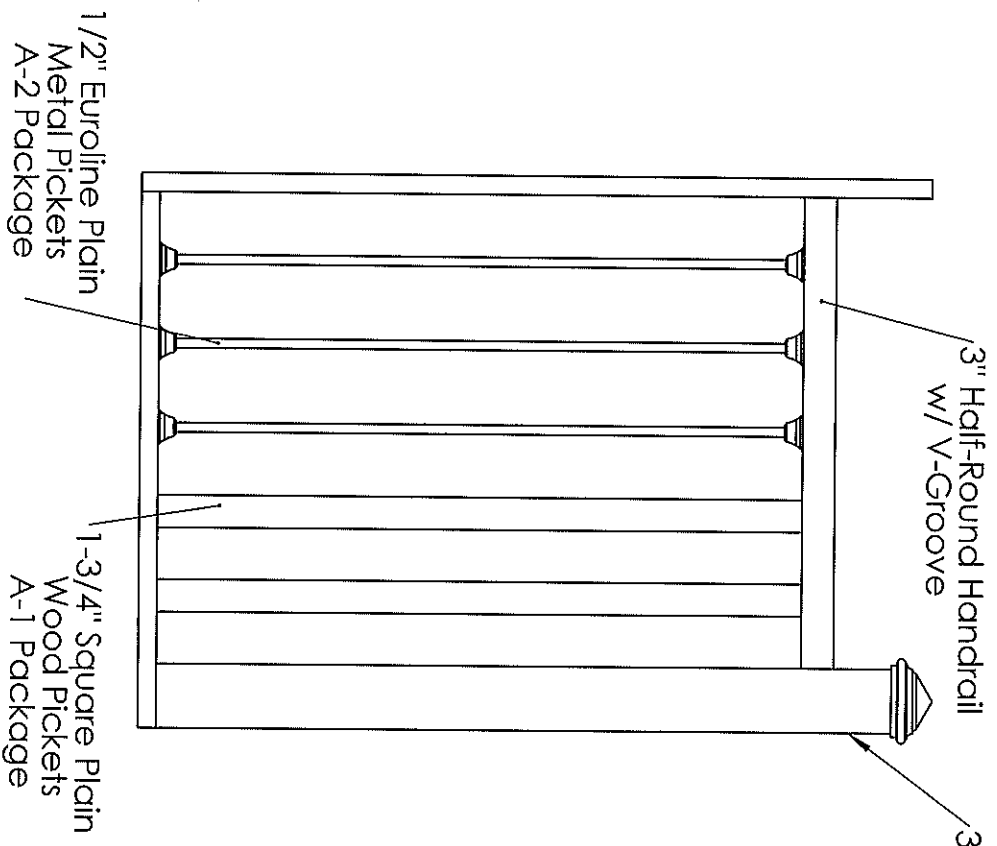

TITLE:

Railing Packages

SIZE : DWG. NO.

A A-1 or A-2 Package

SCALE: 1:20 WEIGHT:

SHEET 1 OF 1

PROPRIETARY AND CONFIDENTIAL

THE INFORMATION CONTAINED IN THIS DRAWING IS THE SOLE PROPERTY OF Airport Railings Co. Ltd. ANY REPRODUCTION IN PART OR AS A WHOLE WITHOUT THE WRITTEN PERMISSION OF Airport Railings Co. Ltd. IS PROHIBITED.

2

1

A

B

2

1

3" Half-Round Handrail
w/ V-Groove

3-1/2" Square Chamfered
Newel Post

A
1-3/4" Square Chamfered
Wood Pickets

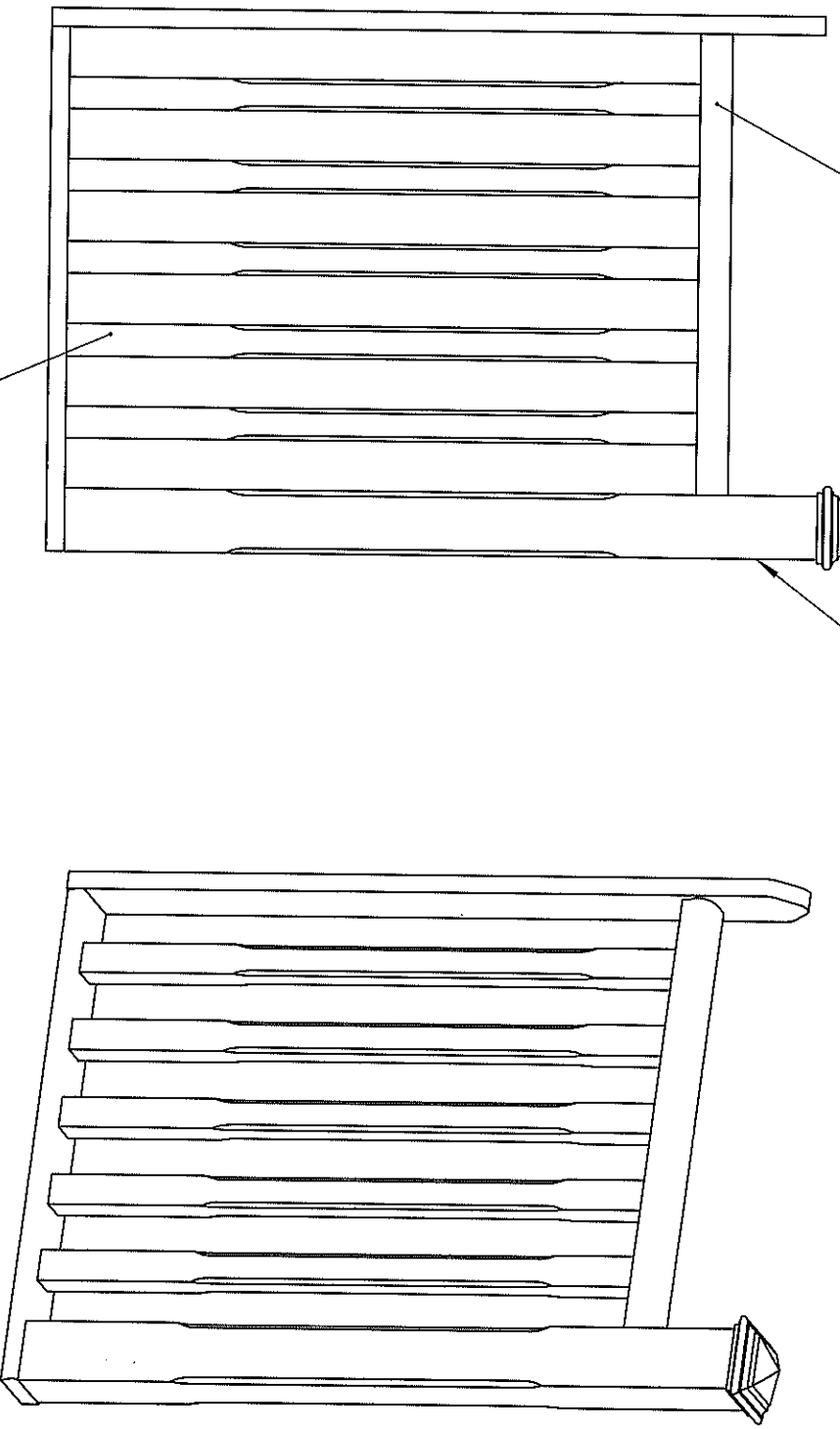

B

B

2

1

TITLE:

Railing Packages

SIZE DWG. NO.

A

B Package

SCALE: 1:20 WEIGHT:

SHEET 1 OF 1

PROPRIETARY AND CONFIDENTIAL
 THE INFORMATION CONTAINED IN THIS
 DRAWING IS THE SOLE PROPERTY OF
 Airport Railings Co., Ltd. ANY
 REPRODUCTION IN PART OR AS A WHOLE
 WITHOUT THE WRITTEN PERMISSION OF
 Airport Railings Co., Ltd. IS PROHIBITED.

A

2

1

A

B

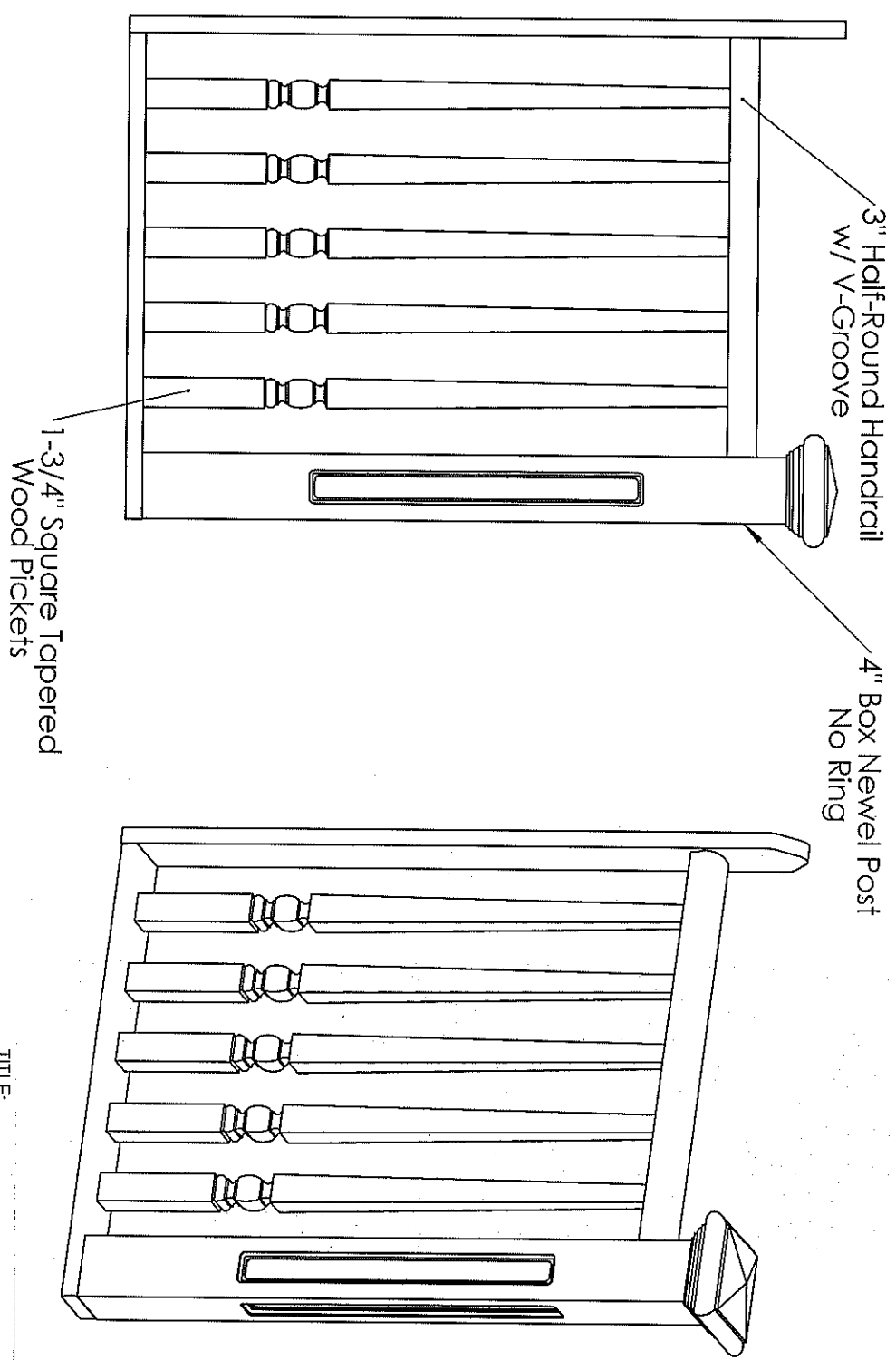

TITLE:

Railing Packages

SIZE DWG. NO.

A C Package

SCALE: 1:20 WEIGHT: SHEET 1 OF 1

PROPRIETARY AND CONFIDENTIAL
 THE INFORMATION CONTAINED IN THIS
 DRAWING IS THE SOLE PROPERTY OF
 Airport Railings Co. Ltd. ANY
 REPRODUCTION IN PART OR AS A WHOLE
 WITHOUT THE WRITTEN PERMISSION OF
 Airport Railings Co. Ltd. IS PROHIBITED.

2

1

A

B

2

1

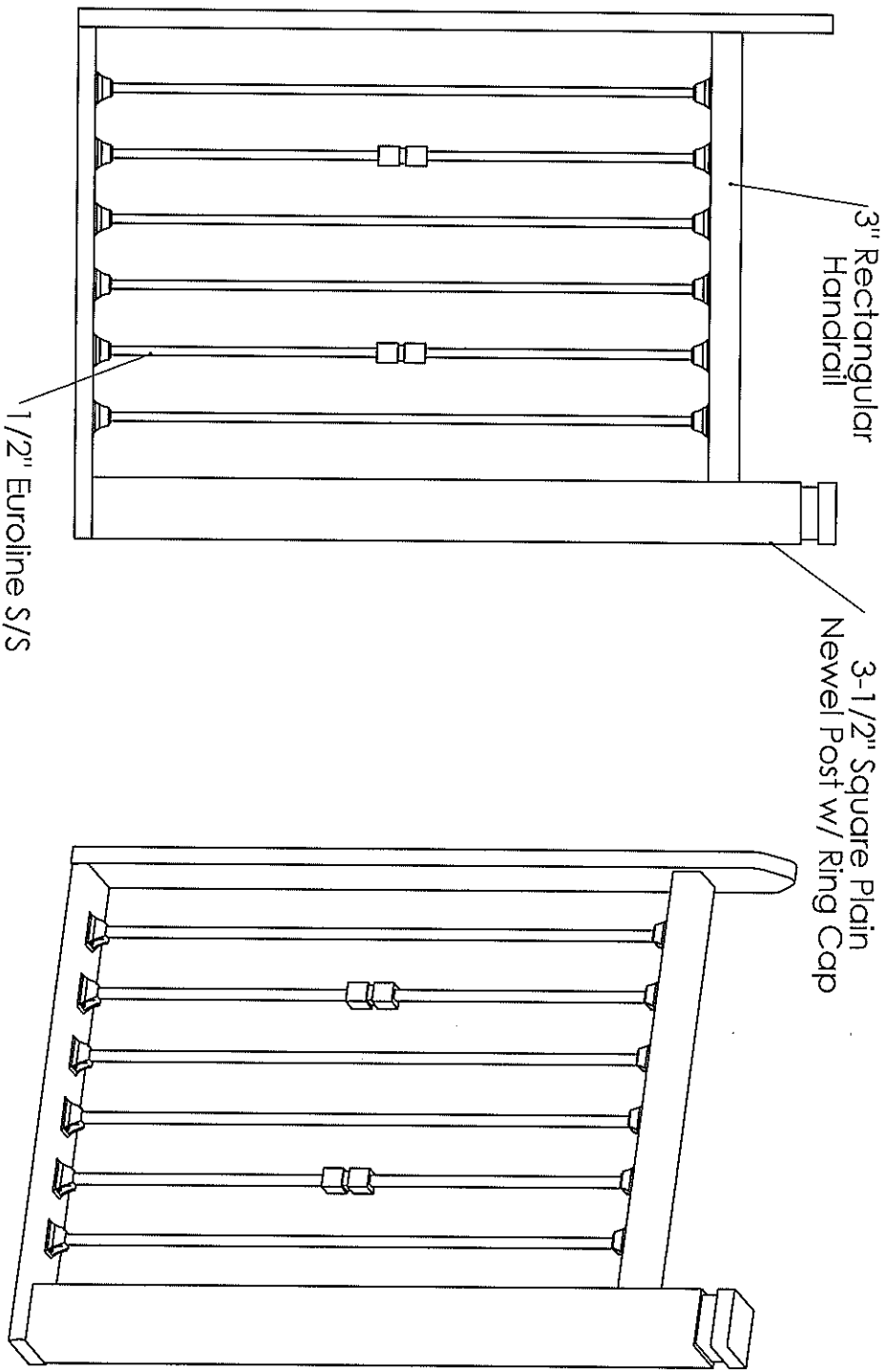

3" Rectangular Handrail

3-1/2" Square Plain Newel Post w/ Ring Cap

1/2" Euroline S/S Metal Picket

B

A

B

A

TITLE:

Railing Packages

SIZE DWG. NO.

A E Package

SCALE: 1:20 WEIGHT: SHEET 1 OF 1

PROPRIETARY AND CONFIDENTIAL
THE INFORMATION CONTAINED IN THIS DRAWING IS THE SOLE PROPERTY OF Airport Railings Co. Ltd. ANY REPRODUCTION IN PART OR AS A WHOLE WITHOUT THE WRITTEN PERMISSION OF Airport Railings Co. Ltd. IS PROHIBITED.

2

1

2

1

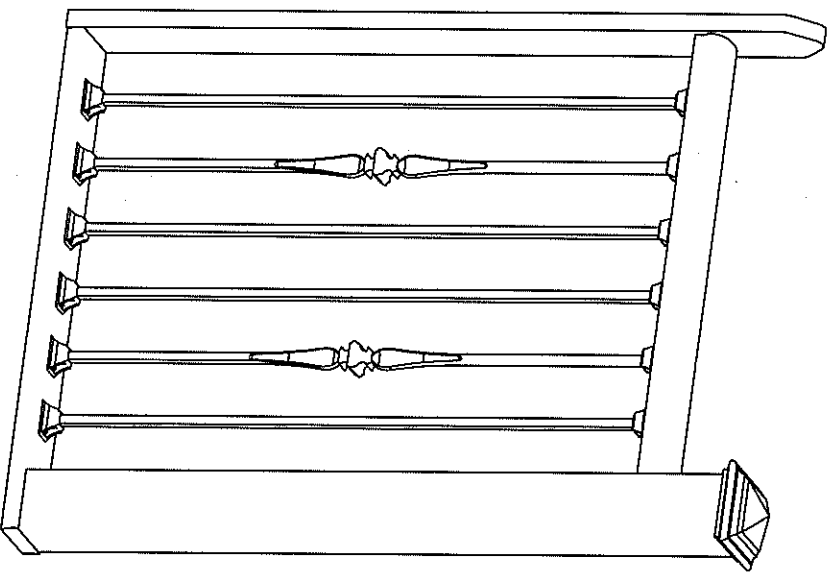
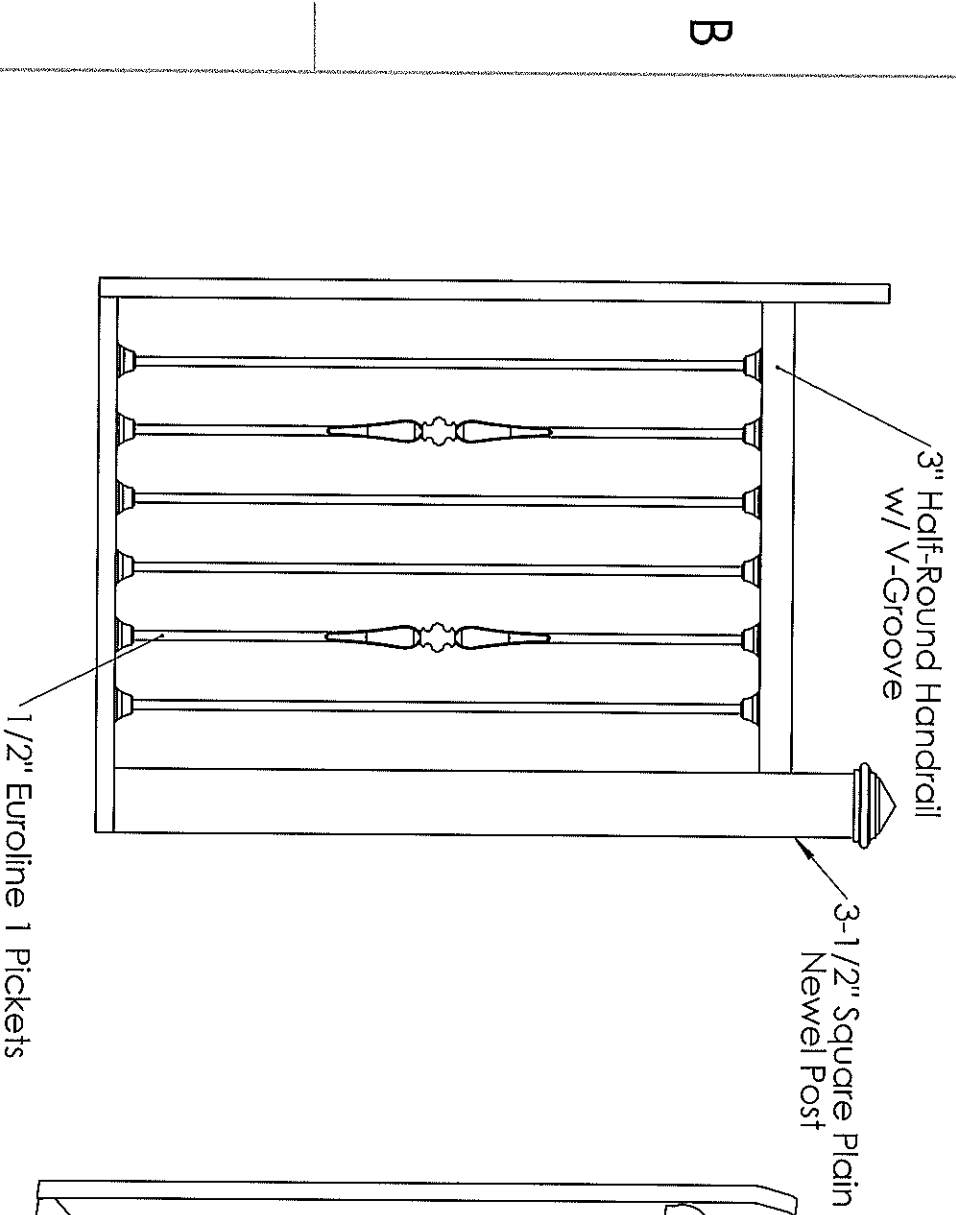

TITLE:

Railing Packages

SIZE DWG. NO.

A D Package

SCALE: 1:20/WEIGHT: SHEET 1 OF 1

PROPRIETARY AND CONFIDENTIAL

THE INFORMATION CONTAINED IN THIS DRAWING IS THE SOLE PROPERTY OF Airport Railings Co. Ltd. ANY REPRODUCTION IN PART OR AS A WHOLE WITHOUT THE WRITTEN PERMISSION OF Airport Railings Co. Ltd. IS PROHIBITED.

A

B

A

B

2

1

2

1

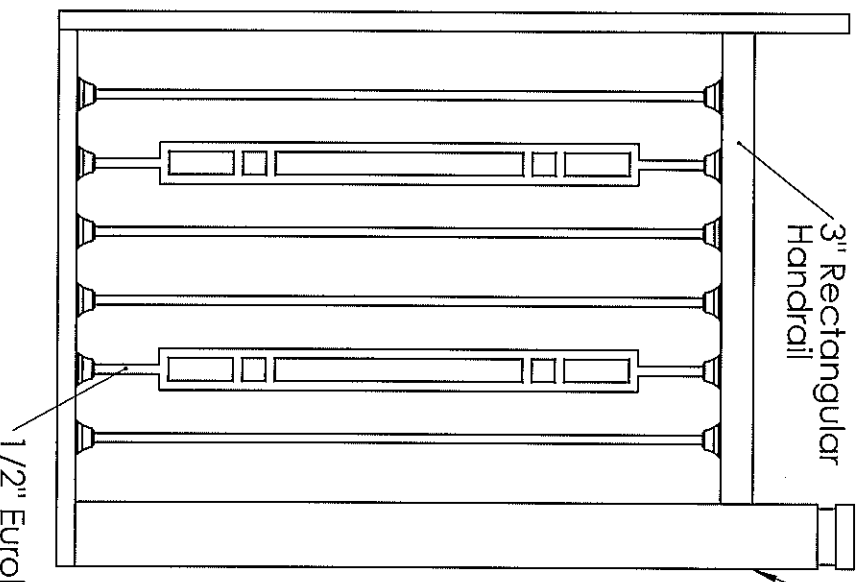

3-1/2" Square Plain Newel Post w/ Ring Cap

1/2" Euroline Contemporary Metal Picket

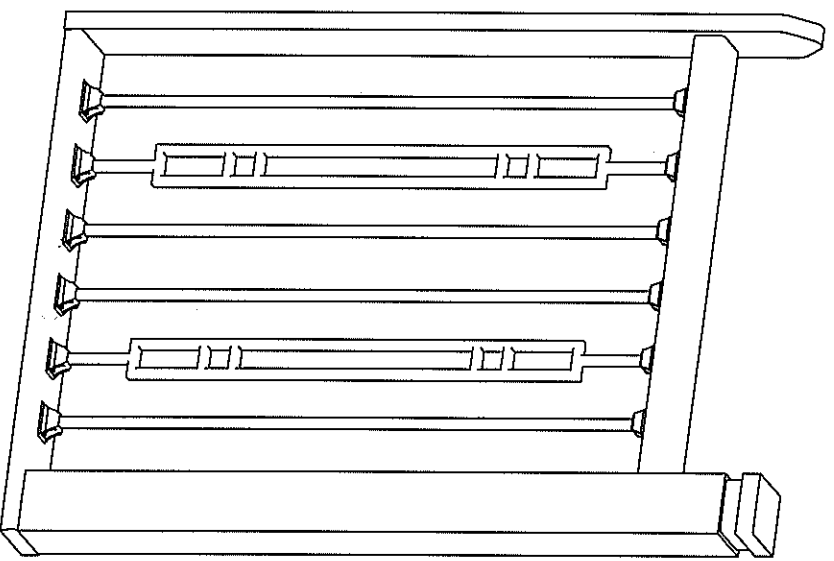

TITLE:

Railings Packages

SIZE DWG. NO.

A

F Package

SCALE: 1:20 (WEIGHT)

SHEET 1 OF 1

PROPRIETARY AND CONFIDENTIAL
 THE INFORMATION CONTAINED IN THIS DRAWING IS THE SOLE PROPERTY OF Airport Railings Co. Ltd. ANY REPRODUCTION IN PART OR AS A WHOLE WITHOUT THE WRITTEN PERMISSION OF Airport Railings Co. Ltd. IS PROHIBITED.

2

1

B

A

B

A

2

1

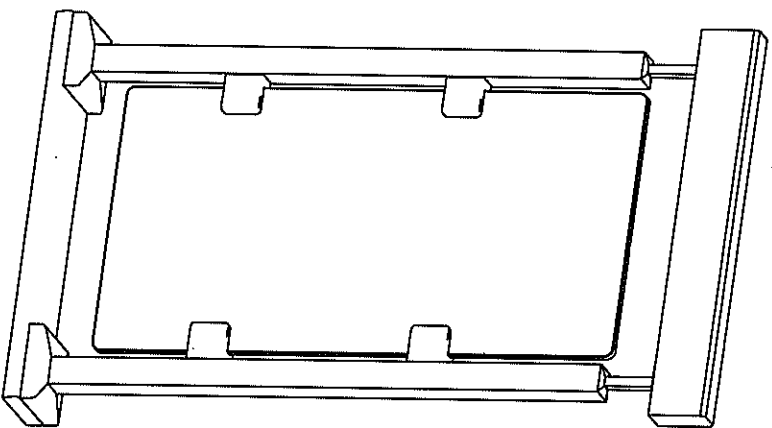
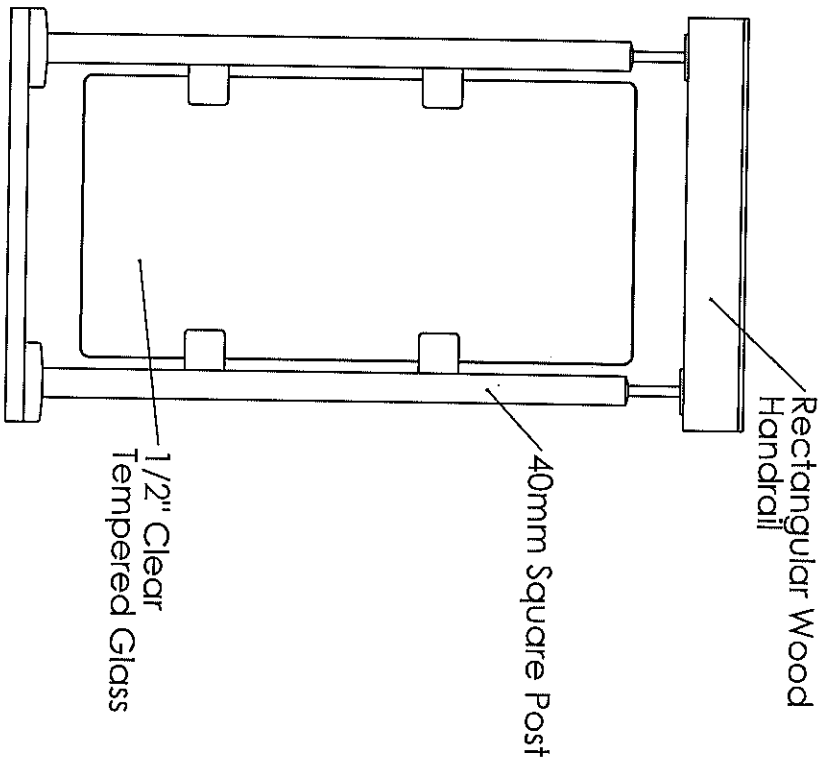

A

B

TITLE:

B

A

Railings Packages

SIZE DWG. NO.

A Stainless and Glass

SCALE: 1:10 WEIGHT: SHEET 1 OF 1

PROPRIETARY AND CONFIDENTIAL
 THE INFORMATION CONTAINED IN THIS DRAWING IS THE SOLE PROPERTY OF Airport Railings Co. Ltd. ANY REPRODUCTION IN PART OR AS A WHOLE WITHOUT THE WRITTEN PERMISSION OF Airport Railings Co. Ltd. IS PROHIBITED.

2

1